



A400

35 t

Prestazioni della gru	
Portata a 3 m da asse ralla (CE)	35 t
Lunghezza braccio (chiuso / aperto)	9.6 / 30.6 m
Altezza testa braccio	31.6 m

Prestazioni del carro⁽¹⁾	
Velocità massima di traslazione (con pneumatici 16.00R25) (La velocità di traslazione è costruttivamente limitata a 25 km/h per la circolazione su strade pubbliche)	34 km/h
Velocità massima di traslazione (con pneumatici 20.5R25) (Versione non omologata per la circolazione su strade pubbliche)	34 km/h
Rampa massima teorica in condizioni di marcia (con pneumatici 16.00R25)	84 %
Rampa massima teorica in condizioni di marcia (con pneumatici 20.5R25)	87 %

⁽¹⁾Gru in versione standard ed in condizioni di marcia: senza argano ausiliario, senza prolunghe

Masse⁽²⁾		
I° assale	II° assale	Totale
11.8 t	15.8 t	27.6 t

⁽²⁾Gru in versione standard: senza argano ausiliario, senza prolunghe, con pneumatici 16.00R25

Velocità / Tempi di lavoro⁽³⁾	
Argano principale (massima in tiro diretto)	80 m/min
Argano ausiliario (massima in tiro diretto)	80 m/min
Sollevamento / Discesa braccio telescopico	65 / 35 s
Sfilo / Rientro braccio telescopico (da 9.6 m a 30.6 m)	90 / 70 s
Rotazione sovrastruttura	30 s
Sfilo singola traversa porta-stabilizzatori	20 s
Sfilo completo singolo stabilizzatore	25 s

⁽³⁾Valori medi di riferimento forniti a puro titolo indicativo

Carro	
Trazione/Sterzo	4x4x4
Telaio	A doppio longherone a cassone. Punto di traino anteriore (in opzione anche posteriore)
Stabilizzatori	n. 4 idraulici indipendenti installati su travi sfilabili idraulicamente. Stabilizzazione con travi parzialmente o completamente estese. Azionamento dalla cabina di guida
Motore	CUMMINS B5.9: 6 cilindri in linea – Cilindrata 5.88 dm ³ - Raffreddato ad acqua con intercooler– Turbocompresso . Potenza massima 113 kW a 2500 giri/min - Coppia massima 614 Nm a 1500 giri/min. Certificazione 97/68/CE Fase 2
Serbatoio	240 l
Trasmissione	DANA serie 20000: Tipo powershift con convertitore di coppia. 3+3 marce avanti e 3+3 retromarce con selezione di gamma lenta e veloce. Inserimento automatico della trazione integrale selezionando la gamma lenta
Freni	Servizio: a doppio circuito a tamburo su tutte le ruote ad azionamento idropneumatico. Stazionamento / Emergenza: negativo sull'albero di trasmissione anteriore del tipo a molla con azionamento pneumatico
Assali	n. 2 assali motori e sterzanti con riduttori epicicloidali nei mozzi. In opzione possibilità di blocco dei differenziali
Sospensioni	Rigida su assale anteriore, oscillazione dell'assale posteriore. Blocco automatico dell'oscillazione posteriore mediante martinetti idraulici quando il braccio di sollevamento non è nel settore anteriore della gru allineato sull'asse di mezzzeria
Sterzo	Idrostatico mediante volante in cabina di guida. Possibilità di sterzata del solo assale anteriore o di entrambi in modalità concentrica o a granchio.
Pneumatici	n. 4 pneumatici 16.00R25 tubeless. In opzione n. 4 pneumatici 20.5R25 tubeless

Sovrastruttura	
Braccio	n. 4 elementi a sezione rettangolare
Sollevamento	n. 1 martinetto idraulico a doppio effetto. Possibilità di inclinazione del braccio da -2° a $+78^{\circ}$
Sfilo	Gli elementi 2 e 3 sono sfilati in modo proporzionale e continuo mediante un martinetto idraulico a doppio effetto e doppia estensione. L'elemento 4 può essere sfilato in modo proporzionale ai precedenti mediante un sistema interno di rinvio a catene. Possibilità di sfilo sotto carico parziale
Argano	Azionato da motore idraulico a pistoni assiali a cilindrata fissa con riduttore epicicloidale. Freno negativo sulla discesa ad inserimento automatico. Dispositivo pressafune. Doppia velocità di rotazione. Fune diametro 15 mm lunghezza 175 m. Capacità massima di sollevamento 3800 daN. In opzione argano ausiliario avente le medesime caratteristiche di quello principale. Fune diametro 15 mm lunghezza 150 m
Rotazione	Continua su 360° mediante motore idraulico e riduttore epicicloidale su ralla a doppio giro di sfere con dentatura interna. Freno negativo ad inserimento automatico. Comando di sblocco del freno per l'allineamento diretto del braccio sulla verticale del carico da sollevare
Cabina	Ad ampia visibilità con sportello scorrevole. Dotata di riscaldamento. Vetro anteriore e superiore con tergicristallo. Vetro superiore e posteriore apribili. Seggiolino completamente regolabile su sospensioni anti-shock, dotato di braccioli sollevabili che integrano i manipolatori per il comando dei vari movimenti della gru.
Sicurezza	Valvole di blocco sui martinetti di sfilo e sollevamento braccio e sugli stabilizzatori. Valvole di massima pressione su ogni circuito idraulico. Valvola di bilanciamento e frenatura su gruppo rotazione. Valvola di bilanciamento e frenatura sull'argano. Interruttore di fine corsa su testa braccio per la salita del bozzello. Interruttore di fine corsa per conservare tre giri di avvolgimento fune sull'argano. Dispositivo limitatore di carico con indicazione: <div style="text-align: right; margin-top: 5px;"> Inclinazione braccio Lunghezza braccio Carico sollevato Massimo carico sollevabile </div>

Impianti	
Idraulico	Alimentazione: n. 1 pompa doppia ad ingranaggi e n. 1 pompa doppia a palette. Controllo movimenti: distributori azionati da manipolatori idraulici con possibilità di manovre simultanee proporzionali. Controllo stabilizzatori: elettrovalvole azionate da pulsanti indipendenti. Filtraggio: n. 1 filtro a cartuccia sul circuito di ritorno. Scambiatore di calore per il raffreddamento dell'olio
Elettrico	a 24 V con alternatore da 70 A e n. 2 batterie da 132 Ah. Dispositivi di illuminazione conformi alle direttive dell'Unione Europea
Pneumatico	Compressore da 247 cm ³ , n. 2 serbatoi da 45 l ciascuno e dispositivo essiccatore. Presa d'aria ausiliaria e kit di gonfiaggio pneumatici

OPZIONALI

Puleggia supplementare su testa braccio
Prolunga da 8 m
Prolunga da 8 + 7 m
Impianto condizionatore caldo/freddo in cabina guida
Ruota di scorta
Kit per operare fino a -20°C
Kit per operare fino a $+45^{\circ}\text{C}$

Crane performance data

Capacity at 3 m from slewing axis (CE)	35 t
Boom length (retracted/extended)	9.6 / 30.6 m
Boom head height	31.6 m

Truck performance data⁽¹⁾

Max. travelling speed (on 16.00R25 tyres)	34 km/h
Max. travelling speed (on 20.5R25 tyres)	34 km/h
Max. theoretical ramp during operation (on 16.00R25 tyres)	84 %
Max. theoretical ramp during operation (on 20.5R25 tyres)	87 %

(1)Standard crane in operating conditions: no auxiliary winch and no extensions

Weights⁽²⁾

1 st axle	2 nd axle	Total
11.8 t	15.8 t	27.6 t

(2)Standard crane: no auxiliary winch and no extensions, on 16.00R25 tyres

Operating speed / times⁽³⁾

Main winch (max. speed under direct pull)	80 m/min
Auxiliary winch (max. speed under direct pull)	80 m/min
Telescopic boom lifting / lowering	65 / 35 s
Telescopic boom extension / retraction (9.6 m to 30.6 m)	90 / 70 s
Upper structure slewing	30 s
Extension of single outrigger beam	20 s
Extension of single outrigger	25 s

(3)Average reference indicative values

Truck

Traction/Steering	4x4x4
Frame	With twin body side member. Front tow point (back tow point on request)
Outriggers	no. 4 independent hydraulic outriggers onto hydraulic beams. Outrigger beams can be partially or fully extended. Outrigger controls in the operating cab.
Engine	CUMMINS B5.9: no. 6 in-line cylinders - displacement: 5.88 cu dm - water cooling with intercooler - turbo supercharger. Max. power 113 kW at 2500 rpm - Max. torque 614 Nm at 1500 rpm. 97/68/CE Step 2 approved.
Tank	240 l
Transmission	DANA series 20000: Powershift-type transmission with torque converter. 3 + 3 forward speeds and 3 + 3 reverse speed: slow and fast speed mode. Automatic engagement of 4WD after selecting slow speed mode
Brakes	Operating brakes: double-circuit hydro-pneumatic drum brakes on all wheels. Parking / Emergency brake: negative action onto front transmission shaft. Pneumatic spring brake.
Axles	no. 2 driving / steering axles equipped with planetary gearboxes into hubs. On request, differential locks
Suspension	Stiff suspension for front axle, swinging suspension for rear axle. Rear suspension is automatically locked by hydraulic jacks if lifting boom is not aligned with centreline within front crane area
Steering	Hydrostatic steering controlled by steering wheel into the operating cab. Steering of front axle alone or both axles in concentric or crab mode.
Tyres	no. 4 16.00R25 tubeless tyres On request, no. 4 20.5R25 tubeless tyres

Upper structure	
Boom	no. 4 rectangular elements
Lifting	no. 1 double action hydraulic jack. Boom inclination: -2° to +78°
Extension	Continuous proportional extension of elements 2 and 3 through double action-double extension hydraulic jack. Proportional extensions of element through inner chain-driven system. Extension under partial load possible.
Winch	Controlled by fixed displacement hydraulic motor equipped with axial pistons and planetary gearbox. Automatic negative brake for winch lowering. Cable tensioner. Two different rotation speeds. Rope diameter 15 mm length 175 m. Max. lifting capacity 3800 daN On request, auxiliary winch featuring same specifications as main winch. Rope diameter 15 mm length 150 m
Slewing	360° non-stop rotation controlled by hydraulic motor equipped with planetary gearbox on slewing ring having double ball ring and inner toothing. Automatic negative brake. Brake release for direct alignment of boom along load vertical line.
Operating cab	Sliding door. Wide visibility. Equipped with heating system. Front and upper window with windscreen wiper. Upper and back windows can be opened. Fully adjustable seat onto shockproof suspensions. Equipped with tiltable arm rests with integrated hand controls for crane operation.
Safety	Stop valves onto extension / lifting boom jacks and outriggers. Max. pressure valves for each hydraulic circuit. Balancing braking valve for the slewing unit. Balancing braking valve for the winch. Limit switch onto boom head for hoisting block lift. Limit switch for having three winding turns around the winch. Load limiting device with indicator for: <ul style="list-style-type: none"> Boom inclination Boom length Load weight Max. load which can be lifted

Systems	
Hydraulic system	Feeding: no. 1 double gear pump and no. 1 double vane pump. Movement control: distributors controlled by hydraulic hand controls. More proportional operations can be carried out at the same time. Outrigger control: solenoid valves controlled by separate buttons. Filtering: no. 1 cartridge filter in return circuit Heat exchanger for oil cooling-down
Electric system	24 V, 70 A generator and no. 2 132 Ah batteries Lighting devices in compliance with current EU directives.
Pneumatic system	247 cu cm compressor, no. 2 45 l reservoirs and drier Auxiliary air intake and tyre inflating kit

OPTIONS

Additional pulley onto boom head
Extension 8 m long
Extension 8 m + 7 m long
Air conditioning / heating system into operating cab
Spare wheel
Operating kit for temperatures up to -20°C
Operating kit for temperatures up to +45°C

Performances de la grue

Capacité à 3 m depuis l'axe d'orientation (CE)	35 t
Longueur de la flèche (fermée / ouverte)	9.6 / 30.6 m
Hauteur tête flèche	31.6 m

Performances du châssis⁽¹⁾

Vitesse maximum de translation (avec pneus 16.00R25)	34 km/h
Vitesse maximum de translation (avec pneus 20.5R25)	34 km/h
Rampe maximum théorique en conditions de marche (avec pneus 16.00R25)	84 %
Rampe maximum théorique en conditions de marche (avec pneus 20.5R25)	87 %

⁽¹⁾ Grue en version standard et en conditions de marche : sans treuil auxiliaire, sans extension

Masses⁽²⁾

I° essieu	II° essieu	Total
11.8 t	15.8 t	27.6 t

⁽²⁾ Grue en version standard : sans treuil auxiliaire, sans extension, avec pneus 16.00R25

Vitesse/ Temps de fonctionnement⁽³⁾

Treuil principal (maximum en tirage direct)	80 m/min
Treuil auxiliaire (maximum en tirage direct)	80 m/min
Relevage / Descente flèche télescopique	65 / 35 s
Télescopage flèche (de 9.6 m à 30.6 m)	90 / 70 s
Orientation partie tournante	30 s
Télescopage traverse simple porte-stabilisateurs	20 s
Télescopage complet simple stabilisateur	25 s

⁽³⁾ Valeurs moyennes de référence fournies à titre purement indicatif

Châssis

Traction/Braquage	4x4x4
Structure	A double longeron à caisson. Point de traction avant (arrière en option)
Stabilisateurs	n. 4 hydrauliques indépendants installés sur traverses à télescopage hydraulique. Stabilisation avec traverses en extension partielle ou en extension complète. Actionnement depuis la cabine de conduite
Moteur	CUMMINS B5.9: 6 cylindres en ligne - Cylindrée 5.88 dm ³ - Refroidi à l'eau avec Intercooler - Turbocompressé. Puissance maximum 113 kW à 2500 tours/min - Couple maximum 614 Nm à 1500 tours/min. Certification 97/68/CE Phase 2
Réservoir	240 l
Transmission	DANA série 20000: Type powershift avec convertisseur de couple. 3+3 marches avant 3+3 marches arrière avec sélection de gamme lente ou rapide. Enclenchement automatique de la traction intégrale en sélectionnant la gamme lente
Freins	Service: à double circuit à tambour sur toutes les roues à actionnement hydropneumatique. Stationnement / Urgence: négatif sur l'arbre de transmission avant du type à ressort avec actionnement pneumatique
Essieux	n. 2 essieux moteurs et de braquage avec réducteurs épicycloïdaux dans les moyeux. En option, possibilité de bloquer les différentiels
Suspensions	Rigide sur l'essieu avant, oscillation de l'essieu arrière. Blocage automatique de l'oscillation arrière au moyen de vérins hydrauliques lorsque la flèche de levage n'est pas dans la zone avant de la grue et alignée sur l'axe de moitié. Hydrostatique depuis volant dans la cabine de conduite.
Braquage	Possibilité de braquage uniquement de l'essieu avant ou des deux essieux en mode concentrique ou en crabe
Pneus	n. 4 pneus 16.00R25 tubeless. En option n. 4 pneus 20.5R25 tubeless

Partie tournante					
Flèche	n. 4 éléments à section rectangulaire				
Relevage	n. 1 vérin hydraulique à double effet. Possibilité d'inclinaison du bras de -2° à $+78^{\circ}$				
Télescopage	Les éléments 2 et 3 sont télescopés de façon proportionnelle et continue au moyen d'un vérin hydraulique à double effet et double extension. L'élément 4 peut être télescopé de façon proportionnelle aux précédents au moyen d'un système interne de renvoi à chaînes. Possibilité de télescopage sous charge partielle				
Treuil	Actionné par un moteur hydraulique à pistons axiaux à cylindrée fixe avec réducteur épicycloïdal. Frein négatif sur la descente à enclenchement automatique. Dispositif serre-câble. Double vitesse de rotation. Câble diamètre 15 mm longueur 175 m. Capacité maximum de levage 3800 daN En option treuil auxiliaire présentant les mêmes caractéristiques que le treuil principal. Câble diamètre 15 mm longueur 150 m				
Orientation	Continue sur 360° au moyen d'un moteur hydraulique et d'un réducteur épicycloïdal sur couronne d'orientation à double tour de billes avec denture interne. Frein négatif à enclenchement automatique. Commande de déblocage du frein pour l'alignement direct de la flèche à la verticale de la charge à lever				
Cabine	A large visibilité avec porte coulissante. Dotée de chauffage. Vitres avant et supérieure avec essuie-glaces. Vitres supérieure et arrière ouvrables. Siège entièrement réglable sur suspension antichoc, doté d'accoudoirs relevables comprenant les manipulateurs pour la commande des différents mouvements de la grue.				
Sécurité	Vannes de blocage sur les vérins de télescopage et levage flèche ainsi que sur les stabilisateurs. Soupapes de pression maximum sur chaque circuit hydraulique. Vanne d'équilibrage et de freinage sur le groupe d'orientation. Vanne d'équilibrage et de freinage sur le treuil. Interrupteur de fin de course sur tête flèche pour la montée de la moufle. Interrupteur de fin de course pour conserver trois tours d'enroulement câble sur le treuil. Limiteur de charge avec indication: <table style="margin-left: auto; margin-right: 0;"> <tr><td>Inclinaison flèche</td></tr> <tr><td>Longueur flèche</td></tr> <tr><td>Charge levée</td></tr> <tr><td>Charge maximum levable</td></tr> </table>	Inclinaison flèche	Longueur flèche	Charge levée	Charge maximum levable
Inclinaison flèche					
Longueur flèche					
Charge levée					
Charge maximum levable					

Circuits	
Hydraulique	Alimentation: n. 1 pompe double à engrenages et n. 1 pompe double à palettes. Contrôles mouvements: distributeurs actionnés par des manipulateurs hydrauliques avec possibilité de manœuvres simultanées proportionnelles. Contrôle stabilisateurs: électrovannes actionnées par des poussoirs indépendants. Filtrage: n. 1 filtre à cartouche sur le circuit de retour. Echangeur de chaleur pour le refroidissement de l'huile
Electrique	à 24 V avec alternateur de 70 A et n. 2 batteries de 132 Ah. Dispositifs d'éclairage conformes aux directives de l'Union Européenne
Pneumatique	Compresseur de 247 cm^3 , n. 2 réservoirs de 45 l chacun et dispositif de séchage. Prise d'air auxiliaire et kit de gonflage des pneus

OPTIONS

Poulie supplémentaire sur tête flèche
Extension de 8 m
Extension de 8 + 7 m
Groupe de climatisation chaud / froid dans la cabine de conduite
Roue de secours
Kit pour intervenir jusqu'à -20°C
Kit pour intervenir jusqu'à $+45^{\circ}\text{C}$

Eigenschaften des Krans	
Tragfähigkeit bei 3 m ab Drehplatte (EG)	35 t
Auslegerlänger (eingefahren / ausgefahren)	9.6 / 30.6 m
Auslegerkopfhöhe	31.6 m

Eigenschaften des Wagens ⁽¹⁾	
Höchstgeschwindigkeit (mit 16.00R25-Reifen)	34 km/h
Höchstgeschwindigkeit (mit 20.5R25-Reifen)	34 km/h
Höchstsollrampe bei Fahrt (mit 16.00R25-Reifen)	84 %
Höchstsollrampe bei Fahrt (mit 20.5R25-Reifen)	87 %

⁽¹⁾ Kran in Standardausführung und bei Betrieb: ohne Zusatzwinde und ohne Auslegerverlängerungen

Gewicht ⁽²⁾		
1. Achse	2. Achse	Gesamt
11.8 t	15.8 t	27.6 t

⁽²⁾ Kran in Standardausführung: ohne Zusatzwinde und ohne Auslegerverlängerungen, mit 16.00R25-Reifen

Betriebsgeschwindigkeit / -zeiten ⁽³⁾	
Hauptwinde (Höchstgeschwindigkeit bei direktem Zug)	80 m/min
Zusatzwinde (Höchstgeschwindigkeit bei direktem Zug)	80 m/min
Heben / Senken des Teleskopauslegers	65 / 35 s
Ausfahren / Einfahren des Teleskopauslegers (von 9.6 m bis 30.6 m)	90 / 70 s
Schwenken des Oberwagens	30 s
Ausfahren eines Stützauslegerträgers	20 s
Vollständiges Ausfahren eines Stützauslegers	25 s

⁽³⁾ Durchschnittswerte; dienen ausschließlich als Richtwerte

Wagen	
Antrieb/Lenkung	4x4x4
Rahmen	Rahmen mit zwei Kastenlängsträgern. Befestigungspunkt vorne (optional auch hinten)
Stützausleger	4 hydraulische unabhängige auf hydraulisch ausfahrbaren Trägern angebrachte Stützausleger. Stützung bei und vollkommen oder teilweise ausgefahrenen Trägern. Steuerung von der Fahrerkabine
Motor	CUMMINS B5.9: Reihenmotor mit 6 Zylindern - Hubraum 5.88 dm ³ - mit intercooler Wasserkühlung - Turbokompressor. Höchstleistung 113 kW bei 2500 U/min - maximales Drehmoment 614 Nm bei 1500 U/min. Zertifizierung: 97/68/EG Stufe 2
Behälter	240 l
Antrieb	DANA-20000: Powershift mit Drehmomentwandler. 3+3 Vorwärtsgänge und 3+3 Rückgänge mit Gangwahl langsam/schnell. Automatischer Vollantrieb in den langsamen Gängen
Bremssystem	Betriebsbremse: hydropneumatische Trommelbremsen mit zwei Leitungen für alle Räder. Feststell- und Notbremse: pneumatische Negativ-Federbremse an der vorderen Antriebswelle
Achsen	2 Trieb- und Lenkachsen mit Planetenumsetzungsgetrieben an den Naben. Differentialsperre optional
Aufhängung	Starre Vorderachsaufhängung, hintere Schwenkachse. Automatische Sperrung der hinteren Schwenkbewegung anhand hydraulischer Hebeböcke wenn sich der Hebearm nicht im Vorderbereich des auf der Mittelachse ausgerichteten Krans befindet
Lenkung	Hydrostatische Lenkung über Lenkrad in der Fahrerkabine. Vorderachsenlenkung oder konzentrische bzw. Krabben-Vollachsenlenkung
Bereifung	4 schlauchlose 16.00R25-Reifen. Optional 4 schlauchlose 20.5R25-Reifen

Oberwagen	
Ausleger	4 Kastenelemente
Heben	1 hydraulischer Hebebock mit Doppelwirkung. Neigung des Auslegers von -2° bis $+78^{\circ}$
Ausfahren	Das 2. und 3. Element können aufgrund eines hydraulischen Hebebocks mit Doppelwirkung und doppelter Ausdehnung proportional und fließend ausgefahren werden. Das 4. Element wird proportional zu den anderen Elementen anhand einer innen angebrachten Kettenrückgewinnung ausgefahren. Ausfahren bei Teilbelastung möglich
Winde	Axialkolben-Hydraulik-Motor mit fester Fördermenge und Planetenumsetzungsgetriebe. Die Absenkbewegung wird automatisch von einer Negativbremse gebremst. Mit Seilklemme ausgestattet. Zwei Drehgeschwindigkeiten. Seildurchmesser 15 mm Länge 175 m. Maximales Hubvermögen 3800 daN. Optionale Zusatzwinde mit denselben Eigenschaften der Hauptwinde. Seildurchmesser 15 mm Länge 150 m
Schwenkung	Dauernde 360° -Schwenkung durch hydraulischen Motor und Planetenumsetzungsgetriebe auf Drehplatte mit doppelter Kugeldrehung und Innenverzahnung. Automatische Negativbremsung. Bremsensperrung zur direkten Anreihung des Auslegers auf der Senkrechten der zu hebenden Last
Fahrerkabine	Gute Sicht, Schiebetür, Heizung. Vorder- und Deckscheibe mit Scheibenwischer. Deck- und Heckscheibe können geöffnet werden. Vollkommen einstellbarer Fahrersitz mit Stoßdämpfung und aufklappbaren Armlehnen, in denen die Manipulatoren für die Steuerung sämtlicher Bewegungen des Krans angebracht sind.
Schutzvorrichtungen	Sperrventile an den Hebeböcken für die Aus- und Einfahr- bzw. Hebebewegung des Auslegers und auf den Stützauslegern. Drucksperrventile an jeder Hydraulikleitung. Ausgleich- und Bremsventil auf der Schwenkeinheit. Ausgleich- und Bremsventil an der Winde. Endschalter am Auslegerkopf für die Hebebewegung des Blocks. Endschalter, damit stets drei Seilwicklungen auf der Winde vorhanden sind. Lastmomentbegrenzer mit folgenden Angaben: <div style="text-align: right; margin-left: 200px;"> Auslegerneigung Auslegerlänge Hublast maximales Hubvermögen </div>

Anlagen	
Hydraulische Anlage	Speisung: 1 Doppelzahnradpumpe, 1 Einzel-Zahnradpumpe und 1 Doppelflügelpumpe. Bewegungssteuerung: durch hydraulische Manipulatoren gesteuerte Verteiler; gleichzeitige Proportionalbewegungen möglich. Stützauslegersteuerung: über unabhängige Druckknöpfe gesteuerte Elektroventile. Filtration: 1 Filter mit Filterkartusche an der Rückleitung. Wärmeaustauscher zur Ölkühlung
Elektrische Anlage	24 V mit Wechselstromgenerator zu 70 A und 2 Akkumulatoren zu 132 Ah. Beleuchtung nach den Richtlinien der Europäischen Union
Pneumatische Anlage	Kompressor zu 247 cm^3 , 2 Behälter jeweils zu 45 l und Trockner. Zusätzlicher Lufteinlass und Reifenfüll-Set

OPTIONALE AUSSTATTUNG

Zusatzrolle am Auslegerkopf
1-teilige Spitze, 8 m.
1-teilige Spitze, 8 + 7 m.
Klimaanlage (warm / kalt) in der Fahrerkabine
Reserverad
Set für den Betrieb bis zu -20°C
Set für den Betrieb bis zu $+45^{\circ}\text{C}$





Capacità di sollevamento, altezze e raggio



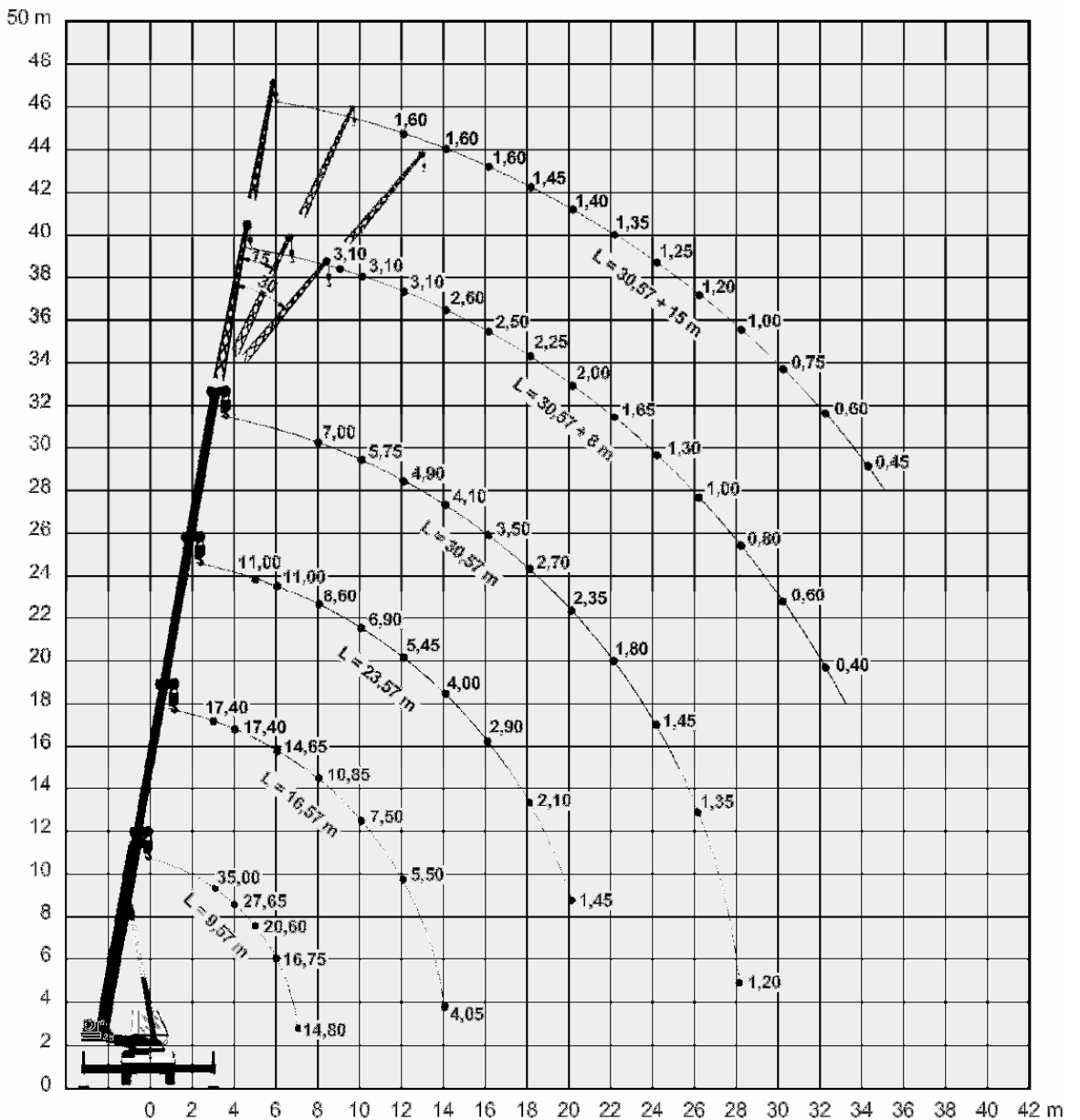
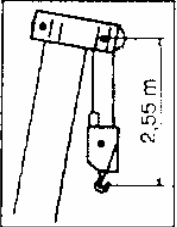
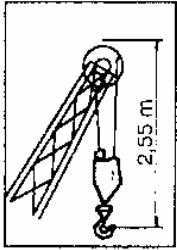
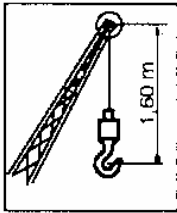



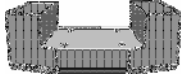

Lifting capacities, heights and radius

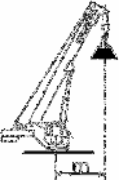
Charges, hauteurs et portées









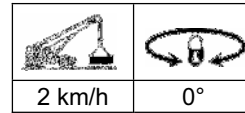
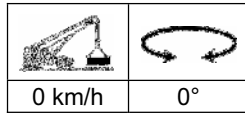
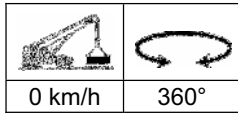
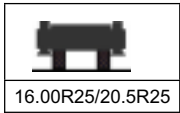

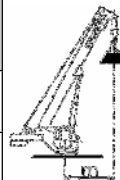
Traglasten / Hubhöhen



				
5.80 m	9.57 m ÷ 30.57 m	5.70 t	360°	

								
	9.57 m	13.07 m	16.57 m	20.57 m	23.57 m	27.07 m	30.57 m	
								
3.0	35.00	22.00	17.40					3.0
3.5	30.10	22.00	17.40					3.5
4.0	27.65	21.00	17.40	12.30				4.0
4.5	25.90	20.90	17.20	12.30				4.5
5.0	20.60	20.25	17.15	12.30	11.00			5.0
6.0	16.75	18.75	14.65	12.20	11.00	9.40		6.0
7.0	14.80	14.80	12.80	10.65	9.65	8.35		7.0
8.0		10.25	10.85	9.30	8.60	7.50	7.00	8.0
9.0		9.10	9.00	8.30	7.65	6.80	6.30	9.0
10.0		7.60	7.50	7.20	6.90	6.20	5.75	10.0
11.0		6.10	6.05	6.25	6.25	5.75	5.30	11.0
12.0			5.50	5.45	5.45	5.30	4.90	12.0
13.0			4.55	4.50	4.50	4.80	4.50	13.0
14.0			4.05	4.00	4.00	4.40	4.10	14.0
15.0				3.50	3.50	4.00	3.70	15.0
16.0				2.90	2.90	3.50	3.50	16.0
17.0				2.50	2.50	3.20	3.20	17.0
18.0				2.20	2.10	2.70	2.70	18.0
19.0					1.75	2.60	2.60	19.0
20.0					1.45	2.35	2.35	20.0
21.0					1.30	2.00	2.00	21.0
22.0						1.80	1.80	22.0
23.0						1.50	1.50	23.0
24.0						1.45	1.45	24.0
25.0							1.40	25.0
26.0							1.35	26.0
27.0							1.25	27.0
28.0							1.20	28.0



										
	9.57 m	13.07 m	9.57 m	13.07 m	16.57 m	9.57 m	13.07 m	16.57 m		
										
3.0			15.40							3.0
3.5			14.00	12.10						3.5
4.0			13.60	12.10	9.10					4.0
4.5		6.90	12.05	12.10	9.10	12.00	12.070			4.5
5.0	5.60	5.70	10.80	10.85	9.10	11.00	11.00			5.0
6.0	4.00	4.05	7.80	8.85	8.85	8.85	8.90	8.55		6.0
7.0	2.90	2.95	6.60	6.75	6.75	6.60	6.75	6.75		7.0
8.0		2.15		5.25	5.30		5.25	5.30		8.0
9.0		1.55		4.15	4.15		4.15	4.15		9.0
10.0		1.05		3.30	3.35		3.30	3.35		10.0
11.0		0.70		2.65	2.75		2.65	2.75		11.0
12.0					2.20			2.20		12.0
13.0					1.75			1.75		13.0
14.0					1.40			1.40		14.0



Outriggers fully extended
Stabilisateurs en extension totale
Stabilizzatori completamente estesi
Voll ausgefahrene Abstützungen



Telescopic boom
Flèche télescopique
Braccio telescopico
Teleskoparm



Outriggers half-extended
Stabilisateurs en extension partielle
Stabilizzatori parzialmente estesi
Teilweise ausgefahrene



Counterweight
Contrepoids
Contrappeso
Gegengewicht



Outriggers unextended
Stabilisateurs fermés
Stabilizzatori chiusi
Eingefahrene Abstützungen

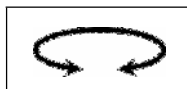

Upperstructure angle rotation
Angle rotation structure du dessus
Angolo rotazione sovrastruttura
Drehwinkel des Strukturaufbaus



Load capacity on wheels
Charges sur pneus
Portate su pneumatici
Tragfähigkeit auf Reifen



Upperstructure rotation lock
Blocage rotation structure du dessus
Rotazione sovrastruttura bloccata
Bolzen des Strukturaufbaus

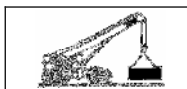

Traveling speed
Vitesse de translation
Velocità traslazione
Bewegungsgeschwindigkeit

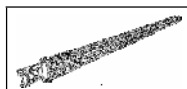

Extension / Jib
Extension / Jib
Prolunga / Jib
Verlängerung / Jib

Taglie di sollevamento / Hoist reeving / Mouflage / Hubrollen										
N° di taglie / No. of line Nbr. de brins / Seilanzahl	1	2	3	4	5	6	7	8	9	10
Argano principale / Main winch / Treuil principal / Hauptwinde										
Carico massimo in kN / Max line pull in kN Charges maxi en kN / Höchstlast in kN	38	76	114	152	190	228	266	304	342	380
Argano ausiliario / Auxiliary winch / Treuil auxiliaire / Zusatzwinde										
Carico massimo in kN / Max line pull in kN Charges maxi en kN / Höchstlast in kN	38	76	114	152	190	228	266	304	342	380

Note	Notes	Notes	Hinweise
<p>I carichi indicati costituiscono i valori massimi coperti dalla garanzia del costruttore per utilizzo rispettivamente secondo le norme della Unione Europea (CE). Sono espressi in tonnellate metriche ed includono il peso del bozzello, delle eventuali prolunghe applicate al braccio e di tutti gli accessori di sollevamento (brache, ecc.)</p> <p>Le operazioni di sollevamento nella configurazione su gomme devono essere effettuate su superficie piana e solida con la corretta pressione di gonfiaggio degli pneumatici e con l'oscillazione dell'assale posteriore bloccata qualora l'operazione non avvenga con braccio entro un settore di +/- 3° rispetto all'asse di mezzeria della autogrù.</p> <p>Le operazioni di traslazione con carico possono avvenire esclusivamente con braccio allineato all'asse di mezzeria della autogrù, perno di bloccaggio meccanico della rotazione della sovrastruttura inserito e avendo cura di mantenere il carico stesso in prossimità della autogrù senza oscillazioni.</p>	<p>The indicated loads are the maximum covered by the manufacturer's warranty for a use which complies with current EU directives (CE). Weights are given in metric tons. They include the weight of the block, all extensions fitted to the boom and all lifting accessories (slings and so on).</p> <p>Crane on wheels: operate the crane on a steady flat surface when hoisting loads and inflate tyres at proper pressure value. Also stop rear axle swinging if the load cannot be lifted having the arm within a +/-3° sector to the crane centreline.</p> <p>The load can be travelled only if the boom is aligned with the crane centreline, the shaft for upper structure rotation stop is fitted and the load is kept close to the crane and is not swinging.</p>	<p>Les charges indiquées constituent les valeurs maximales couvertes par la garantie du fabricant pour une utilisation conforme aux normes de l'Union Européenne. Elles sont exprimées en tonnes métriques et comprennent le poids de la moufle, des éventuelles extensions appliquées à la flèche et de tous les accessoires de levage (élingues, etc.).</p> <p>Les opérations de levage dans la configuration sur pneus doivent être effectuées sur une surface plane et solide avec une pression de gonflage des pneus correcte et l'oscillation de l'essieu arrière bloquée si l'opération n'a pas lieu avec la flèche située dans une zone de +/- 3° par rapport à l'axe de moitié du camion-grue.</p> <p>Les opérations de translation avec charge ne peuvent être effectuées qu'avec flèche alignée dans l'axe de moitié du camion-grue, goujon de blocage mécanique de la rotation de la structure du dessus enclenché et en prenant soin de maintenir la charge à proximité du camion-grue sans oscillations.</p>	<p>Die angegebenen Lasten sind die Grenzwerte, für welche die Herstellergarantie bei Einsatz gemäß den Normen der Europäischen Union (EU). Die Grenzwerte sind in Metertonnen ausgedrückt, das Gewicht des Blocks, eventueller am Ausleger angebrachter Verlängerungen und jeglicher Hebezubehörteile (Schlingen usw.) ist inbegriffen.</p> <p>Hebearbeiten mit bereiftem Kran müssen auf einer ebenen und festen Oberfläche erfolgen; die Reifen müssen richtig befüllt und die Hinterachse festgestellt sein, wenn der Ausleger außerhalb eines Bereichs von +/- 3° im Verhältnis zur Mittelachse des fahrbaren Krans gehoben wird. Transportarbeiten mit belastetem Ausleger sind ausschließlich erlaubt, wenn der Ausleger an der Mittelachse des Krans angereicht ist, der mechanische Verriegelungszapfen, der die Drehung des Oberwagens verhindert, eingerastet ist und die Last ohne zu schwingen in Nähe des Krans behalten wird.</p>

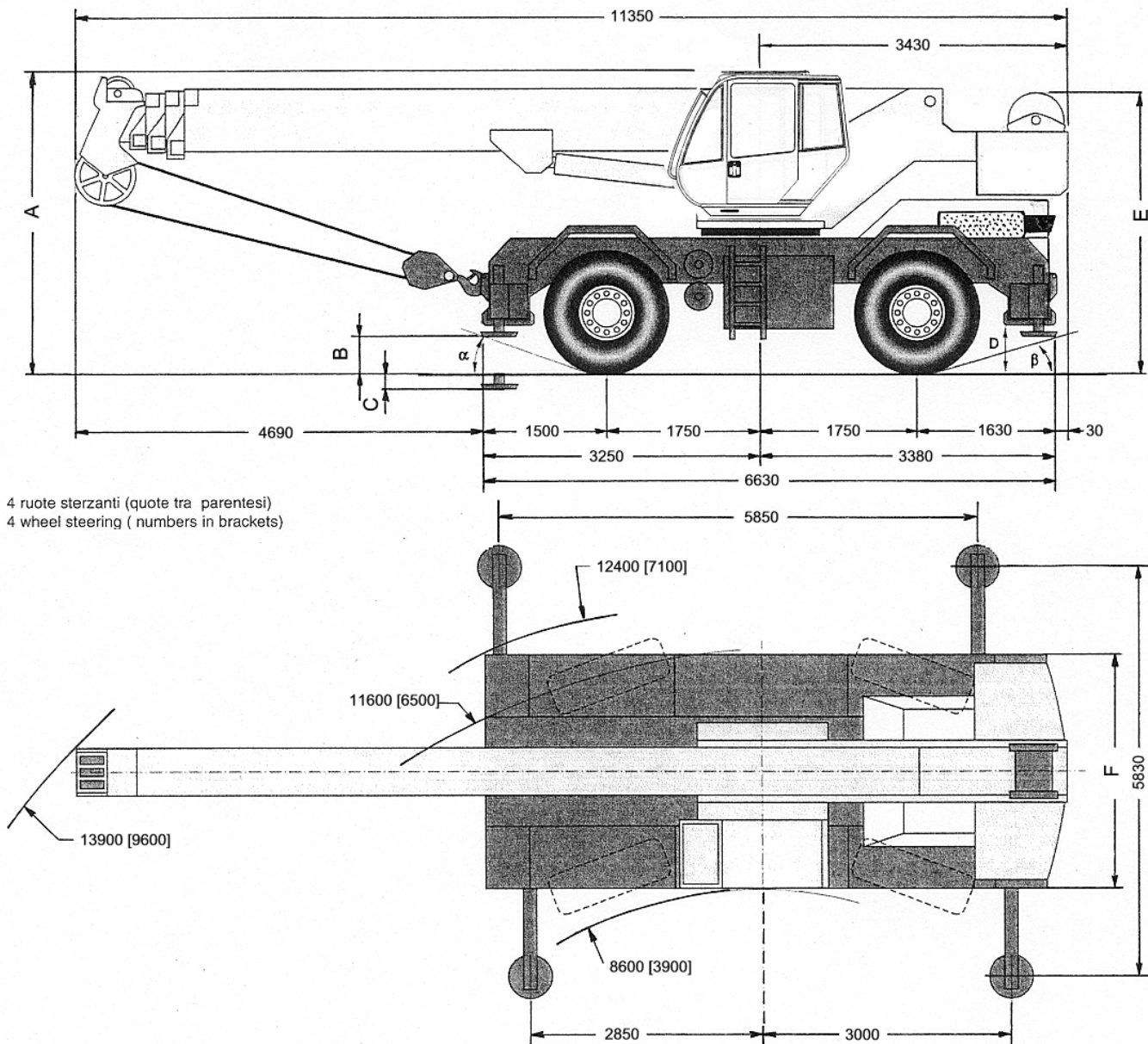

Dimensioni / Dimensions / Dimensions / Abmessungen⁽⁴⁾

Pneumatici / Tyres Pneumatiques / Reifen	A	E	C	B	D	F	α	β
16.00R25	3450	3300	190	360	410	2550	21°	20°
20.5R25	3445	3295	195	355	405	2670	21°	20°

(4) Dimensioni medie di riferimento fornite a puro titolo indicativo. Valori espressi in millimetri
 (4) Average reference values, which are indicative only. Values are expressed in mm
 (4) Dimensions moyennes de référence fournies à titre purement indicatif. Valeurs exprimées en millimètres
 (4) Durchschnittsmaße; dienen ausschließlich als Richtwerte. Die Werte sind in Millimetern ausgedrückt

Note	Notes	Notes	Hinweise
Tutte le caratteristiche e le specifiche descritte possono essere soggette a variazioni senza preavviso. Tutti i dati riportati sono forniti a puro titolo informativo e non costituiscono una garanzia dal momento che le prestazioni della macchina variano in funzione dell'utilizzo. La sola garanzia applicabile è quella fornita da TEREX Italia per i propri prodotti	All specifications and features herein described can be changed without prior advice. All indicated data are indicative only and are not binding as crane performs differently depending on its use. Only the warranty terms granted by TEREX Italia for their products can be applied.	Toutes les caractéristiques et spécifications décrites peuvent être sujettes à variations sans préavis. Toutes les données indiquées sont fournies à titre purement indicatif et n'engage pas la responsabilité du fabricant dans la mesure où les performances de la machine varient en fonction de l'utilisation. La seule garantie applicable est celle fournie par TEREX Italia pour ses propres produits.	Unangekündigte Änderungen sämtlicher Eigenschaften und Daten sind möglich. Alle Angaben sind Richtwerte und nicht verbindlich, da die Leistungen der Vorrichtung von deren Einsatz abhängen. Die einzige gültige Garantie ist jene der Firma TEREX Italia für die von dieser hergestellten Produkte.



ISO 9001 - Cert. 1151/1

Cod. 38723 Rev. 5 del 07/05



TEREX ITALIA
Via Cassoletta 76
40056 CREPELLANO (BO) - ITALY
tel.: (+39) 0516501011
fax: (+39) 051734645
e-mail: terexitalia@terex.it
www.terex.it

