



sarens
group

www.sarens.com

Terex A300

30 ton

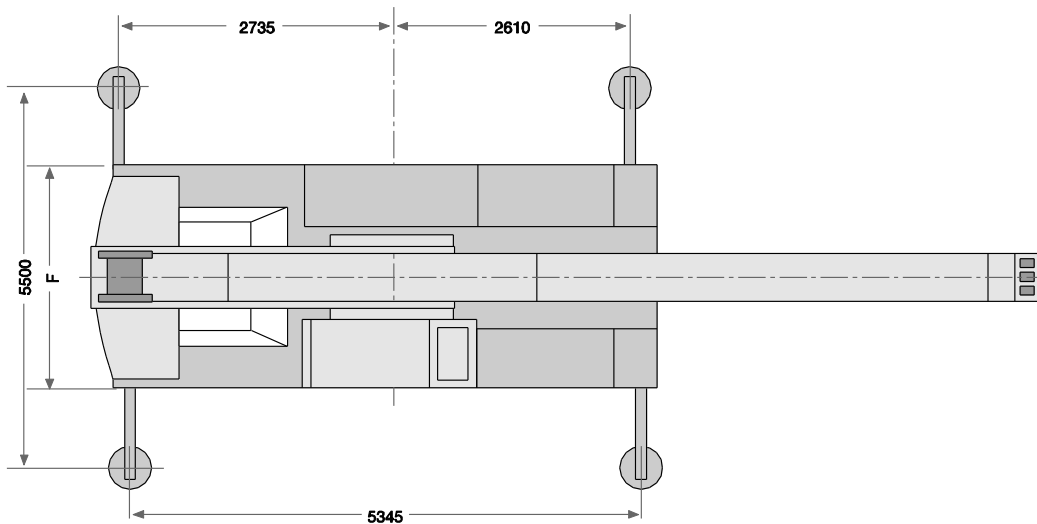
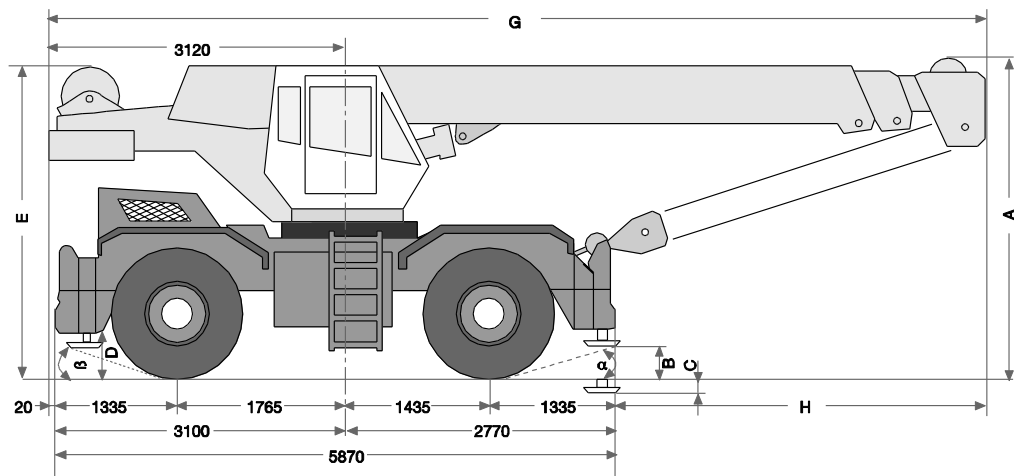

nothing too heavy, nothing too high





Terex A300

Working ranges
Portées

30 ton

Arbeitsbereiche
Werkbereich

Ha / HaV

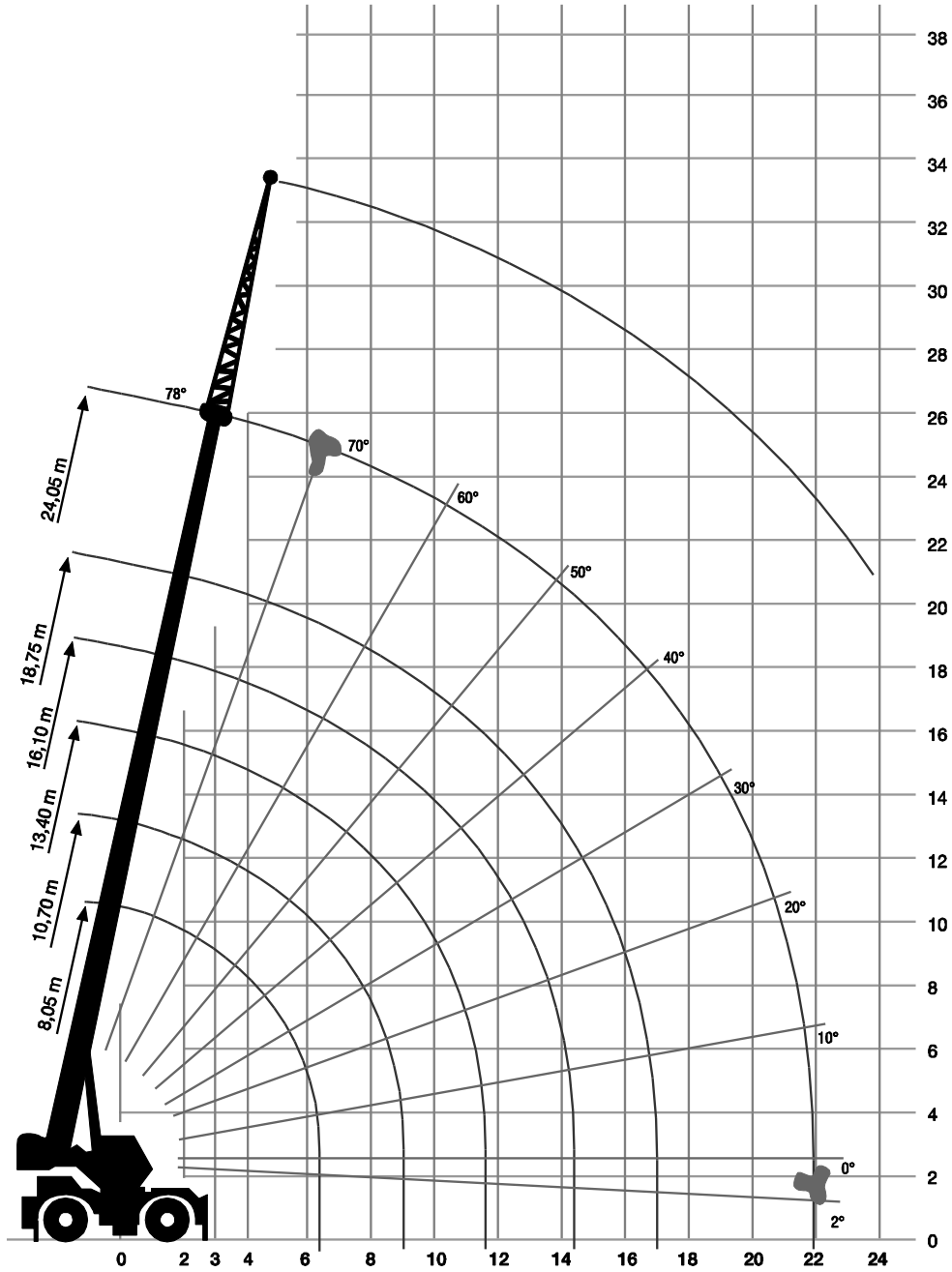

nothing too heavy, nothing too high





Terex A300

Capacities
Capacités

30 ton

Tragfähigkeiten
Capacités



Ha

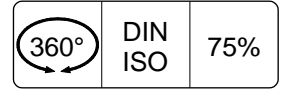
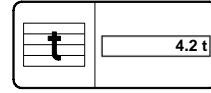

m	8.05m	10.70m	13.40m	16.10m	18.75m	24.05m
	t	t	t	t	t	t
3.0	30.0	23.0	21.0	19.0	-	-
3.5	25.0	23.0	20.0	18.6	-	-
4.0	22.5	22.5	20.0	16.9	13.8	-
4.5	20.0	20.0	18.5	15.0	13.0	-
5.0	18.0	18.0	17.0	14.0	12.5	8.4
6.0	14.5	14.5	14.0	12.1	11.0	8.0
7.0	-	11.2	11.2	10.6	9.5	7.0
8.0	-	8.9	8.9	8.9	8.3	6.3
9.0	-	-	7.5	7.5	7.2	5.8
10.0	-	-	6.3	6.3	6.3	5.6
11.0	-	-	5.1	5.1	5.1	4.7
12.0	-	-	-	4.4	4.4	4.2
13.0	-	-	-	3.7	3.7	3.8
14.0	-	-	-	3.3	3.3	3.5
15.0	-	-	-	-	2.9	3.1
16.0	-	-	-	-	2.6	2.8
17.0	-	-	-	-	2.3	2.4
18.0	-	-	-	-	-	2.3
19.0	-	-	-	-	-	2.1
20.0	-	-	-	-	-	1.7
21.0	-	-	-	-	-	1.6
22.0	-	-	-	-	-	1.5

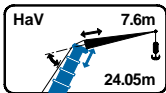

HaV

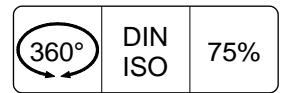
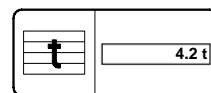

m	24.05m MB / 7.6m jib	
	0°	
m	t	
7.0	4.00	
8.0	3.70	
9.0	3.40	
10.0	3.20	
11.0	3.00	
12.0	2.80	
13.0	2.60	
14.0	2.40	
15.0	2.20	
16.0	2.10	
17.0	1.90	
18.0	1.80	
19.0	1.60	
20.0	1.50	
21.0	1.30	
22.0	1.20	
23.0	1.10	
24.0	1.00	

nothing too heavy, nothing too high



Terex A300

**Capacities
Capacités**

30 ton

**Tragfähigkeiten
Capaciteiten**

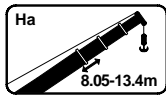

Ha

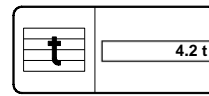

m	360°			0°				0°		
	8.05m	10.70m	13.40m	8.05m	10.70m	13.40m	16.10	8.05m	10.70m	13.40m
3.0	10.50	-	-	16.00	-	-	-	13.00*	-	-
3.5	7.80	7.80	-	12.00	11.50	-	-	10.00*	10.00*	-
4.0	5.10	5.10	5.10	8.40	8.40	8.40	-	8.00*	8.00*	8.00*
4.5	-	3.90	3.90	-	6.00	6.00	6.00	-	6.00*	6.00*
5.0	-	2.90	2.90	-	5.00	5.00	5.00	-	5.00*	5.00*
6.0	-	-	2.15	-	-	3.70	3.70	-	-	3.60*
7.0	-	-	1.60	-	-	3.10	3.10	-	-	3.00*
8.0	-	-	-	-	-	2.40	2.40	-	-	2.30*
9.0	-	-	-	-	-	-	1.50	-	-	-
10.0	-	-	-	-	-	-	1.10	-	-	-

*0° Locked

**Working speeds
Vitesses de travail**

**Arbeitsgeschwindigkeiten
Werksnelheden**

Mechanisms Mécanismes Antriebe Aandrijvingen	Speeds Vitesses Geschwindigkeiten Snelheden	Rope diameter Diamètre du câble Seildurchmesser Kabeldiameter	Single line pull Effort sur brin simple Zulässiger Seilzug je strang Toegelaten trekkracht / part	Length of ropes Longueur des cables Länge der Seile Kabellengte
Main hoist Levage sur flèche Hubwerk 1 Hijslier 1	50 m/min	15 mm	38 kN	140 m
Slewing gear Orientation Drehwerk Zwenkwerk	35 s			
Travel speed Vitesse sur route Fahrgeschwindigkeit Rijsnelheid	36 / 38 km/h			
Booming up Relever la flèche Aufwippen Optoppen	35 / 45 sec			
Telescope Téléscoper Teleskopieren Telescoperen	8.05 - 18.75 m	50 / 25 sec		

**Hook Block / Crane hook
Crochet mouflé / Crochet simple**

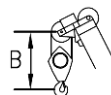

**Unterflasche / Hakengehänge
Kraanblok / Kraanhaak**

Capacity Capacité Tragfähigkeit Capaciteit	Number of sheaves Nombre de poulies Anzahl der Rollen Aantal schijven	Number of lines Nombre de brins Strangzahl Aantal parten	Weight Poids Gewicht Gewicht	"B"
SWL 10.0 t				
SWL 5.0 t				

V.2012-07-12

nothing too heavy, nothing too high